

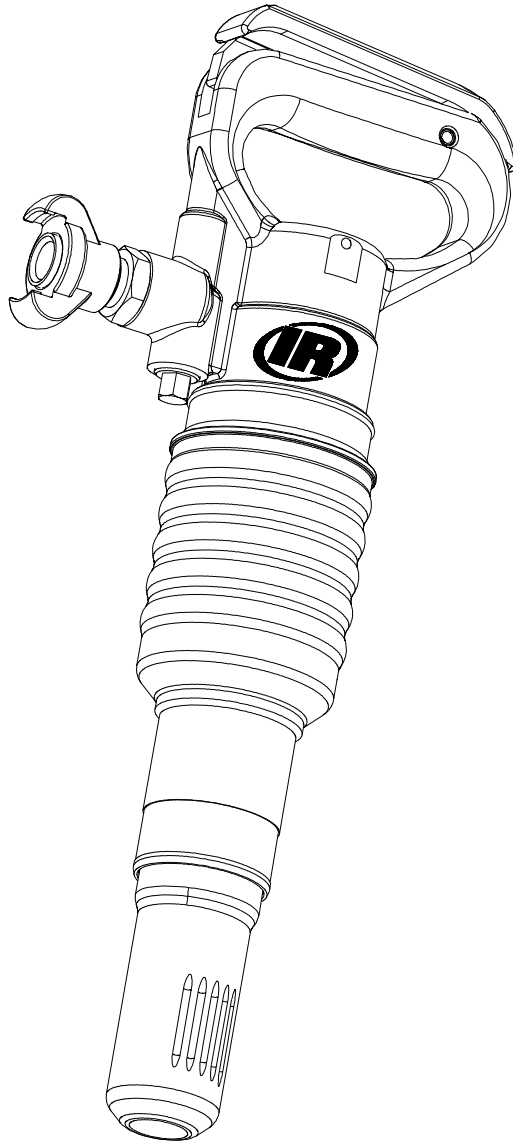

Ingersoll Rand®

OPERATION AND MAINTENANCE
IR10PV AND IR12PV



This manual contains important safety information and must be made available to personnel who operate and maintain this machine

SERIAL NO: CZ02G00001 →

CPN: 85042927 GB
DATE: 07/2002

PORTABLE POWER PRODUCT WARRANTY

Ingersoll-Rand, through its distributor, warrants that each item of equipment manufactured by it and delivered hereunder to the initial user will be free of defects in material and workmanship for a period of three (3) months from initial operation or six (6) months from the date of shipment to the initial user, whichever occurs first.

With respect to the following types of equipment, the warranty period enumerated below will apply in lieu of the foregoing warranty period.

- A. Aftercoolers** – The earlier of nine (9) months from date of shipment to or six (6) months from initial operation by initial user.
- B. Portable Compressors, Portable Generator Sets – 9 Kva through to 550 Kva, Portable Light Towers and Air Dryers** – The earlier of twelve (12) months from shipment to or the accumulation of 2,000 hours of operation by the initial user.
2.5 Kva Through to 8 Kva – The earlier of twelve (12) months from shipment to or the accumulation of 2,000 hours of operation by the initial user.
Ingersoll-Rand will provide a new part or repaired part, at its sole discretion, in place of any part which is found to be defective in material or workmanship during the period described above. Labour cost to replace the part is the responsibility of the initial user.
- C. Portable Compressor Air Ends** – The earlier of twenty-four (24) months from shipment to or the accumulation of 4,000 hours of operation by the initial user. For Air Ends, the warranty against defects will include replacement of the complete Air End, provided the original Air End is returned assembled and all original seals are intact.
- D. Portable Compressor Airend Limited Extended Warranty** – The earlier of sixty (60) months from shipment to or the accumulation of 10,000 hours of operation by the initial user. This extended warranty is limited to defects in design or defective material or workmanship in rotors, housings, bearings and gears and provided all the following conditions are met:
 - 1. The original air end is returned assembled and all original seals are intact.
 - 2. Continued use of genuine Ingersoll-Rand parts, fluids, oil and filters.
 - 3. intervals by authorised and properly trained service engineers.
- E. Generator Alternator – 9 Kva through to 550 Kva**, the earlier of twenty-four (24) months from shipment to or the accumulation of 4,000 hours of operation by the initial user.
2.5 Kva Through to 8Kva – The earlier of twelve (12) months from shipment to or the accumulation of 2,000 hours of operation by the initial user.
- F. Portable Light Tower Alternator** – The earlier of twelve (12) months from shipment to or the accumulation of 2,000 hours of operation by the initial user. Light Source model only, the earlier of twenty-four (24) months from shipment to or the accumulation of 4,000 hours of operation by the initial user.
- G. Ingersoll-Rand Engines** – The earlier of twenty-four (24) months from shipment to or the accumulation of 4,000 hours of operation by the initial user.
- H. Ingersoll-Rand Platinum Drive Train Limited Extended Warranty** – Platinum drive train refers to the Ingersoll-Rand Engine and Airend combination. The ear-

lier of sixty (60) months from shipment to, or the accumulation of 10,000 hours of operation by the initial user. The starter, alternator, fuel injection system and all electrical components are excluded from this extended warranty. The airend seal and drive coupling are included in the warranty but airend drive belts are excluded. This limited extended warranty is automatically available when meeting the following conditions:

- 1. The original airend is returned assembled and unopened.
 - 2. Continued use of genuine Ingersoll-Rand parts, fluids, oil and filters.
 - 3. Maintenance is performed at prescribed intervals by authorised and properly trained service engineers.
- I. 1. Construction Tools, (Portable Power range only)** – Twelve months from shipment to initial user. Ingersoll-Rand will provide a new part or repaired part, at its sole discretion, in place of any part which is found to be defective in material or workmanship during the period described above. Labour cost to replace the part is the responsibility of the initial user.
2. Construction Tools Limited Extended Warranty, (Portable Power range only) – Thirty-six (36) months from shipment to initial user. This extended warranty is automatically available only when the tool is registered with Ingersoll-Rand by completing and submitting the Warranty Registration form. Ingersoll-Rand will provide a new part or repaired part, at its sole discretion, in place of any part which is found to be defective in material or workmanship during the period described above. Labour cost to replace the part is the responsibility of the initial user.
 - J. Spare Parts** – Six (6) months from date of shipment to the initial user. Ingersoll-Rand will provide a new part or repaired part, at its sole discretion, in place of any part that is found to be defective in material and workmanship during the period described above. Such parts will be repaired or replaced without charge to the initial user during normal working hours at the place of business of an Ingersoll-Rand distributor authorised to sell the type of equipment involved or other establishment authorised by Ingersoll-Rand. User must present proof of purchase at the time of exercising warranty. The above warranties do not apply to failures occurring as a result of abuse; misuse, negligent repairs, corrosion, erosion and normal wear and tear, alterations or modifications made to the product without express written consent of Ingersoll-Rand; or failure to follow the recommended operating practices and maintenance procedures as provided in the product's operating and maintenance publications.

Accessories or equipment furnished by Ingersoll-Rand, but manufactured by others, including, but not limited to, engines, tires, batteries, engine electrical equipment, hydraulic transmissions, carriers, shall carry only the manufacturers warranty, which Ingersoll-Rand can lawfully assign to the initial user.

THE ABOVE WARRANTIES ARE IN LIEU OF ALL OTHER WARRANTIES EXPRESSED OR IMPLIED, (EXCEPT THAT OF TITLE), AND THERE ARE NO WARRANTIES OF MERCHANTABILITY OR OF FITNESS FOR A PARTICULAR PURPOSE.

Machine models represented in this manual may be used in various locations world-wide. Machines sold and shipped into European common market countries requires that the machine display the EC Mark and conform to various directives. In such cases, the design specification of this machine has been certified as complying with EC directives. Any modification to any part is absolutely prohibited and would result in the CE certification and marking being rendered invalid. A declaration of that conformity follows:

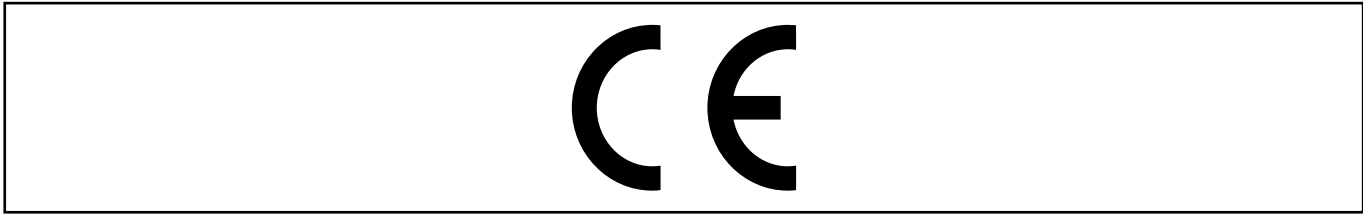

DECLARATION OF CONFORMITY WITH EC DIRECTIVES

98/37/EC, 2000/14/EC

We

Ingersoll –Rand Company
 Portable Power Division P.O.
 Box 868
 501 Sandford Avenue
 Mocksville,
 North Carolina 27028
 USA

Represented in EC by

Ingersoll –Rand Company Ltd
 Portable Power Division
 Swan Lane
 Hindley Green
 Wigan WN2 4EZ
 United Kingdom

Declare that under our sole responsibility for manufacture and supply, the product(s)

Pickhammer Type IR10PV and IR12PV

To which this declaration relates, is (are) in conformity with the provisions of the above directives using the following principal standards

EN292, BSEN28662-5,

Issued at Mocksville on 1-7-2002

Issued at Hindley Green on 1-7-2002

Ric Lynsford
 Manager of Quality Control

Harry Seddon
 Quality Assurance Manager

**CONFORMITY TO NOISE DIRECTIVE
 2000/14/EC**

Ingersoll -Rand Company Limited declare that the following Pickhammers have been manufactured in conformity with the directive as shown

Directive	Machine Model	Weight Range	Mean Measured Value	Garanteed Level	Notified Body
2000/14/EC Annex VI Part 1	IR10PV	10 kg	98 L _{WA}	107 L _{WA}	A V Technology Stockport UK Nr. 1067
	IR12PV	12 kg	100 L _{WA}	105 L _{WA}	

Harry Seddon
 Quality Assurance Manager

Issued at Hindley Green
 1st Declaration... 07/2002

Look for these signs on machines shipped to markets in North America, which point out potential hazards to the safety of you and others. Read and understand thoroughly. Heed warnings and follow instructions. If you do not understand, inform your supervisor.



DANGER

Red Background

Indicates the presence of a hazard which WILL cause serious injury, death or property damage, if ignored.



CAUTION

Orange Background

Indicates the presence of a hazard which CAN cause serious injury, death or property damage, if ignored.



WARNING

Yellow Background

Indicates the presence of a hazard which WILL or can cause injury or property damage, if ignored.

NOTICE

Blue Background

Indicates important set-up, operating or maintenance information.

NOTICE

IR10PV and IR12PV Pick Hammers are designed for the disintegration of low to medium strength materials (e. g. concrete, masonry bituminous asphalt etc). The tool is intended for vertical or inclined downward breaking.
Ingersoll – Rand is not responsible for customer modifications of tools for applications on which Ingersoll – Rand was not consulted.



WARNING

**IMPORTANT SAFETY INFORMATION ENCLOSED.
READ THIS MANUAL BEFORE OPERATING TOOL.
IT IS THE RESPONSIBILITY OF THE EMPLOYER TO PLACE THE INFORMATION
IN THIS MANUAL INTO THE HANDS OF THE OPERATOR.
FAILURE TO OBSERVE THE FOLLOWING WARNINGS COULD RESULT IN INJURY.**

PLACING TOOL IN SERVICE

- Always operate, inspect and maintain this tool in accordance with all regulations (local, state, federal and country), that may apply to hand held/hand operated pneumatic tools.
- For safety, top performance, and maximum durability of parts, operate this tool at 103 psig (7.0 bar/700 kPa) maximum air pressure at the inlet with 3/4" (19 mm) inside diameter air supply hose.
- Always turn off the air supply and disconnect the air supply hose before installing, removing or adjusting any accessory on this tool, or before performing any maintenance on this tool.
- Do not use damaged, frayed or deteriorated air hoses and fittings.
- Be sure all hoses and fittings are the correct size and are tightly secured. See Dwg. PP1 for a typical piping arrangement.
- Always use clean, dry lubricated air at 103 psig (7.0 bar/700 kPa) maximum air pressure. Dust, corrosive fumes and/or excessive moisture can ruin the motor of an air tool.
- Do not lubricate tools with flammable or volatile liquids such as kerosene, diesel or jet fuel.
- Do not remove any labels. Replace any damaged label.

USING THE TOOL

- Always wear eye protection when operating or performing maintenance on this tool.
- Always wear hearing protection when operating this tool.
- Keep hands, loose clothing and long hair away from rotating end of tool.
- Anticipate and be alert for sudden changes in motion during start up and operation of any power tool.
- Keep body stance balanced and firm. Do not overreach when operating this tool.
- Tool accessories may continue to impact briefly after throttle is released.
- Air powered tools can vibrate in use. Vibration, repetitive motions or uncomfortable positions may be harmful to your hands and arms. Stop using any tool if discomfort, tingling feeling or pain occurs. Seek medical advice before resuming use.
- Use accessories recommended by Ingersoll-Rand.
- This tool is not designed for working in explosive atmospheres.
- This tool is not insulated against electric shock.

NOTICE

The use of other than genuine Ingersoll-Rand replacement parts may result in safety hazards, decreased tool performance, and increased maintenance, and may invalidate all warranties.
Repairs should be made only by authorised trained personnel. Consult your nearest Ingersoll-Rand Authorised Servicer.

WARNING LABEL IDENTIFICATION

**WARNING**

FAILURE TO OBSERVE THE FOLLOWING WARNINGS COULD RESULT IN INJURY.

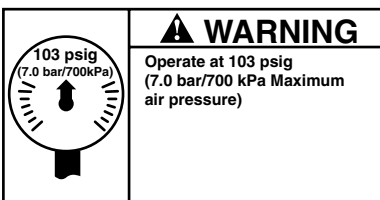
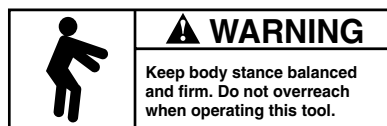
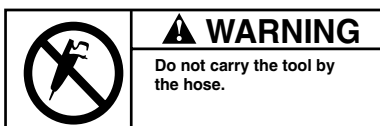
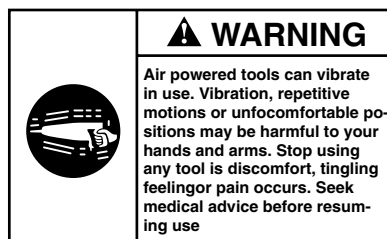
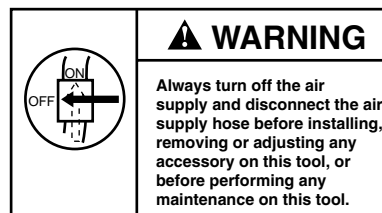
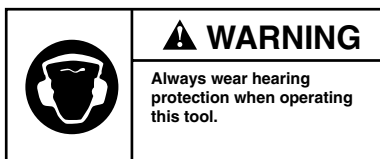
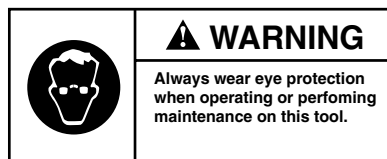

SPECIFIC WARNINGS

- When wearing gloves and operating models with inside trigger, always be sure that the gloves will not prevent the trigger from being released.
- Wear safety shoes, hard hat, safety goggles, gloves, dustmask and any other appropriate protective clothing while operating the tool.
- Do not indulge in horseplay. Distraction can cause accidents.
- Keep hands and fingers away from the throttle lever until it is time to operate the tool.
- Never rest the tool or chisel on your foot.
- Never point the tool at anyone.
- Compressed air is dangerous. Never point an air hose at yourself or co-workers.
- Never blow clothes free of dust with compressed air.
- Be sure all hose connections are tight. A loose hose not only leaks but can come completely off the tool and while whipping under pressure, can injure the operator and others in the area. Attach safety cables to all hoses to prevent injury in case a hose is accidentally broken.
- Never disconnect a pressurised air hose. Always turn off the air supply and bleed the tool before disconnecting a hose.
- The operator must keep limbs and body clear of the chisel. If a chisel breaks, the tool with the broken chisel projecting from the tool will suddenly surge forward.
- Do not ride the tool with one leg over the handle. Injury can result if the chisel breaks while riding the tool.
- Know what is underneath the material being worked. Be alert for hidden water, gas, sewer, telephone or electric lines.
- Use only proper cleaning solvents to clean parts. Use only cleaning solvents which meet current safety and health standards. Use cleaning solvents in a well-ventilated area.
- Do not flush the tool or clean any parts with diesel fuel. Diesel fuel residue will ignite in the tool when the tool is operated, causing damage to internal parts. When using models with outside triggers or throttle levers, take care when setting the tool down to prevent accidental operation.
- Do not operate the tool with broken or damaged parts.
- Never start the tool when it is lying on the ground.
- This tool is not designed for working in explosive atmospheres.
- This tool is not insulated against electric shock.

PLACING TOOL IN SERVICE

LUBRICATION



Protec Engine Oil

Always use an air line lubricator with these tools. We recommend the following Lubricator-Unit and Lubricant:

In Line Lubricator: CPN: 35371111
 Lubricant: Protec Engine Oil CPN: 85448405

Attach the lubricator as close to the tool as practical.

After each two or three hours of operation and at the beginning of each work shift, if an air line lubricator is not used, disconnect the air hose and pour about 3 cc of oil into the air inlet of the tool.

Before storing the tool or if the tool is to be idle for a period exceeding twenty-four hours, pour about 3 cc of oil into the air inlet and operate the tool for 5 seconds to coat the internal parts with oil.

INSTALLATION

Air Supply and Connections

Always use clean, dry lubricated air. Dust, corrosive fumes and/or excessive moisture can ruin the motor of an air tool. An air line filter can greatly increase the life of an air tool. The filter removes dust and moisture.

Make sure all hoses and fittings are the correct size and are tightly secured. See diagram PP1 for a typical piping arrangement.

The tool is shipped from the factory with 3/4" NPT male inlet thread and quick release coupling.

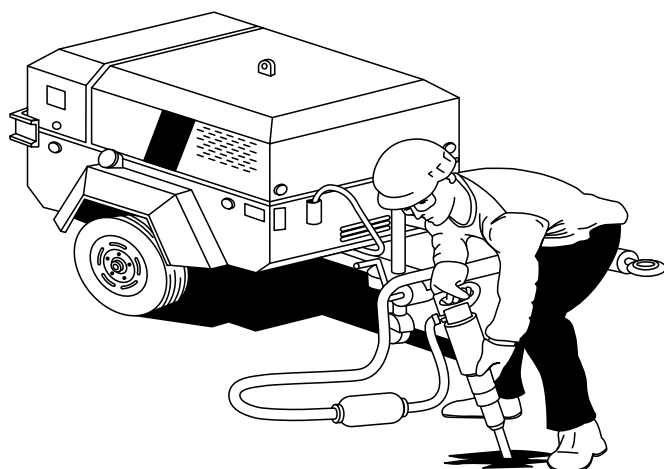

Diagram PP1

OPERATION

Accessory Installation



WARNING

Always turn off the air supply and disconnect the air supply hose before installing, removing or adjusting any accessory on this tool or before performing any maintenance on this tool. Failure to do so could result in injury.

For Screw - on type Retainer

1. Grasp the Retainer and unscrew from the Barrel.
2. Insert the accessory through the Retainer Assembly and install it on the tool. Screw the Retainer onto the barrel until you feel the Retainer O-ring drop into the groove in the Retainer.

For Latch Type Retainer

1. Operate the Latch until it is approximately 90 degrees to the body of the tool and clicks into position.
2. Insert the accessory into the tool until the collar of the accessory is past the Latch.
3. Operate the Latch until it is parallel to the tool and it clicks into position.



NOTICE

Do not repair the tool at the work site. Always take the tool to a repair shop. Never drag the tool on the ground. The air port and other openings will become clogged with dirt and debris.



CAUTION

Compressed air is dangerous. When blowing the line clear of dirt, wear eye protection and keep the air line directed toward a safe, clear area.

Always blow out the air line before using to clear the line of dirt.



CAUTION

Do not operate the tool unless the chisel is against the work since this will cause premature wear of parts and reduce the vibration isolation properties of the tool.

Always break material to the point of "give." Cracking does not result in a complete break. Clear away rubble as it is broken since uncleared rubble blocks the point of "give."

Always take the right size "bite" with the tool. When working new material, experiment to find the right size "bite" required for breaking that material efficiently.



NOTICE

If "bites" are too big, the operator will try to pry with the tool. This could break the chisel. The tool is designed for demolition, not prying. Always use a pick for prying. If "bites" are too small, the operator will be working too slowly.

If the chisel or accessory should become stuck, do not use excessive force or mechanical means on the tool to pull out the chisel. Doing so will damage the vibration isolation unit. Break out the stuck chisel with a spare chisel or tool.

DISASSEMBLING THE IR10PV AND IR12PV PICKHAMMERS

GENERAL INSTRUCTIONS

- Clean the Pickhammer outer surface.
- Do not disassemble the pickhammer any further than necessary to replace or repair damaged or worn parts.
- Whenever grasping a pickhammer or a part in a vice, always use leather or copper-covered vice jaws to protect the surface of the part and help prevent distortion. Take extra care with threaded parts and housings.
- Do not remove any part that is a press fit in or on a sub-assembly unless the removal of the part is necessary for repairs or replacement.
- Do not disassemble the pickhammer unless a complete set of O-rings is available for replacement.

DISASSEMBLY OF THE FRONTHEAD

Screw retainer models

Unscrew retainer (12) off the cylinder (1) and remove chisel buffer (13) from inside retainer. Remove seal ring (8) from its groove in the cylinder.

Latch retainer models

Remove nut (17) and fronthead pinch bolt (16) from the fronthead (15). Lightly tap the fronthead (using a hide mallet if necessary) off the cylinder (1).

Press or drift out the two fronthead spring pins (18, 19) and remove the latch lever (20).

The plunger (22) and plunger spring (21) can be removed from the fronthead.

MAIN DISASSEMBLY

Grip handle body casting (24) firmly in a vice (use leather or copper covered vice jaws).

Insert three or four pieces of thin sheet steel approximately 8mm wide up into the muffler and beneath the retaining lip of the muffler moulding (9) from the handle end of the cylinder. This will allow the rubber retaining lip of the muffler to slide along past the groove in the cylinder nut (11) and make removal of the muffler easier. Note that the bearing sleeve and muffler are removed together. Slide muffler (9) and bearing sleeve (10) off over the cylinder assembly (1).

Use a small screwdriver to disengage the end of the locking ring (40) from the hole in the cylinder nut (11). Rotate the locking ring in its groove a little to prevent re-locking. (Removal of the locking ring is not necessary unless replacement is required.)

Use a large spanner (75 mm) across the flats of the cylinder nut (11) and unscrew the nut from the cylinder assembly. Remove the anti-rotation key (7) from its slot in the handle body (24). The key is provided with an M5 tapped hole to aid removal by a jacking screw if necessary.

The cylinder assembly (1) may now be slid from the handle assembly (23), take care to prevent loss of the cylinder spring (6) and o-ring (38).

HANDLE DISASSEMBLY

Grip handle body (24) in a vice (use leather or copper covered vice jaws).

Unscrew throttle valve plug (29) using a 13 mm spanner. Withdraw throttle valve spring (28), throttle valve ball (27) and throttle valve plunger (26).

Remove the throttle lever (25) by pressing or drifting out spring pin (26).

Unscrew quick release coupling (31) from inlet bushing (30). The inlet bushing (30) can be removed if required though it is assembled into the handle using a high strength retainer and disassembly is not normally necessary.

CYLINDER DISASSEMBLY

Note: The cylinder assembly should not be disassembled unless there is evidence of excessive wear of the piston striking face, or evidence of excessive wear of the cylinder (1) bore, cushion bore or piston (3) diameters. Physical inspection of the above parts will require a new cylinder plug (6) and all O-rings to be available for re-assembly.

Tests to estimate wear in cylinder assembly components.

First thoroughly clean and degrease the whole cylinder assembly inside and out and blow dry. – **Caution: wear suitable personal protection, barrier cream, gloves and eye protection. Read any instructions and warnings specific to the degreasing agent.**

- *Piston striking face.*

If an indent caused by chisel contact, of approximately 0.5mm deep can be felt in the piston striking face – replace the piston.

- *Cushion wear: (Test dry without oil)*

Hold the cylinder so the piston slides fully towards the valve end. Quickly invert and bring the cylinder vertical allowing the piston to fall towards the retainer end. If a metal to metal noise can be heard at the end of the piston stroke an air cushion is not present and a new cylinder assembly (1) and/or piston (3) may be required.

Note: Continued use of the hammer with insufficient cushion will result in premature cylinder failure.

- *Cylinder bore or piston diameter wear.*

Wear affecting these parts may have occurred if low hitting power is reported.

First ensure all airways into, and out from exhaust ports including muffler of tool are clear. Disassembly and precise measurement of the diameters will be required to confirm wear.

Disassembly

Grip the cylinder (1) horizontally in a vice (use leather or copper covered vice jaws).

Insert a mild steel bar of approx 20mm diameter by 300mm long into the nozzle end of the cylinder and using a copper mallet drive out the cylinder plug (5) with the piston (3).

Note: The cylinder plug (6) is non metallic and is retained by a lip which will be destroyed when removed in this manner.

Caution:

Wear suitable eye protection, and be aware that the piston may be ejected or fall and cause injury.

The valve ring (4) may be removed by gently opening at the split and sliding the ring over the end of the cylinder.

Note: Take care not to stretch the ring.

Remove O-rings (38 may stick in handle body), (37), (36), and (39).

The nozzle (2) is pressed into the cylinder and retained with Loctite 601 – do not disassemble unless replacement is necessary.

The cylinder plugs (35) should not be removed, however check that they are present.

Inspect valve spring pins (33) and (34) for signs of wear and security.

ASSEMBLY OF THE IR10PV AND IR12PV PICKHAMMERS

GENERAL INSTRUCTIONS

- Before assembly of the breaker, clean all parts thoroughly and lubricate surfaces with a thin film of recommended oil – (see lubrication).
- Apply a thin film of O-ring lubricant to all O-rings before final assembly.
- It is recommended that the assembly of the nozzle (2) be carried out by the manufacturer or authorised distributor.
- The existence of a piston air cushion should be determined. Hold the cylinder vertically and allow the piston to drop down the bore small diameter first. An air cushion is present if the piston “bounces”, at the bottom of the cylinder and no metal to metal contact noise can be heard. If a cushion is not present contact your authorised Ingersoll – Rand repair centre for advice.

CYLINDER ASSEMBLY

Grip the cylinder (1) vertically nozzle down, in a vice protected with leather or copper covered vice jaws.

If the cylinder has been disassembled completely rebuild in the following order.

Lubricate and insert the piston (3) small end first into the bore.

Locate the pilot diameter of cylinder plug (5) in cylinder bore and gently tap home using a hide mallet.

Gently spread apart the ends and slide valve ring (4) onto the cylinder. Locate the split around the valve spring pins (33) and (34).

Lubricate and replace the O-rings (37) & (36) in their grooves.

HANDLE ASSEMBLY

Position throttle lever (25) in its slot in the handle casting and align the holes in each part.

Drift or press home the spring pin (26). Check the throttle lever is free to move easily.

Grip the handle casting (24) in a vice protected with leather or copper covered vice jaws.

Lubricate and insert throttle valve plunger (26) into position reduced diameter out of the hole.

Replace the throttle valve ball (27) and spring (28) and retain in place with throttle valve plug (29), apply loctite 243 to the threads of the plug and screw home fully.

If the air inlet (30) has been removed, refit it into the handle casting using Loctite 243 and screw home fully.

Replace the quick release coupling (31).

MAIN ASSEMBLY

Firmly grip the handle assembly (23) vertically in a vice (protected with leather or copper covered vice jaws).

Position the O-ring (38) and stand the cylinder spring (6) centrally at the bottom of the handle bore

Carefully slide the cylinder assembly (1) into the cylinder until the key slot in the handle body (24) aligns with the mating slot in the cylinder assembly (1). **Note:** Take care not to dislodge the cylinder spring off its face in the handle.

Lubricate the slot in the cylinder and replace the anti-rotation key.

Note: Check the handle is free to slide on the cylinder.

Remove the pickhammer from the vice.

Ensure that O-ring (39) is in place on the cylinder (nozzle end).

Lower the cylinder nut (11) onto the handle and cylinder assembly, engage the handle threads of the nut and tighten by hand. Fully tighten the Cylinder nut using a (75mm) spanner until the lock hole in cylinder nut (11) aligns with a hole in the handle body.

Note: Sight or feel for correct alignment with a suitably sized wire. Snap the locking ring pin in place. Slide the muffler (9) together with bearing sleeve (10) down the cylinder until the muffler retaining lip engages with the groove in the cylinder nut (11).

ASSEMBLY OF THE FRONTHEAD – SCREW RETAINER MODELS

Replace the sealing ring (8) in its groove in the cylinder. Inspect the chisel buffer (13) for wear and replace if necessary, by sliding a new buffer into the retainer.

Note: Premature failure of the cylinder may occur if a worn chisel buffer (13) is not replaced. Ingersoll – Rand recommend that the buffer (13) is checked frequently during use and replaced if necessary.

Screw the retainer onto the cylinder assembly.

ASSEMBLY OF THE FRONTHEAD – LATCH RETAINER MODELS

Grease the latch plunger (22) and plunger spring (21) and insert them into position in the fronthead (15).

Locate the latch lever (20) with the holes in the fronthead and press or drift into place the fronthead spring pins (18,19).

Check the operation of the latch.

Slide the fronthead (15) onto the end of the cylinder and align the bolt hole with the groove machined in the cylinder.

Fit fronthead pinch bolt (16) and secure with nut (17) tighten to 90 Nm (66.4 lbs.ft) torque.

ASSEMBLY CHECKS

Following service or repair the pickhammer should be checked for correct operation before being sent back to the job site.

Fit the correct size accessory into the pickhammer and connect to an airline. Using low pressure 2 bar (30psi) check to ensure the pickhammer is free of air leaks around the inlet connection and also that the pickhammer does not automatically start to operate without the trigger being depressed.

Increase the air pressure to 6 bar (90psi) and run the tool in short bursts to check the tools starts and stops cleanly and without hesitation.

Pickhammer operating frequency should be as given in the specification table at the end of this manual.

SPECIFICATIONS FOR IR10PV AND IR12PV PICK HAMMERS

Model	Chuck Size	Retainer Type	Cpn	Overall Length mm (in)	Overall Width mm (in)	Weight kg (lbs)	Max Working Pressure bar (psi)	Air Consumption m ³ /min @ 6 bar (CFM)	Certified Vibration Level m/s ² @ 6 bar	Impact Frequency /min	Fronthead Nut Torque Nm (ft.lbs)
IR10PV	25 round × 75	Screw	85041986	516 (20.3)	190 (7.5)	10 (22)	7 (103)	1.0 (35)	5.1	2040	–
IR10PV	22 hex. × 82	Screw	85041994	516 (20.3)	190 (7.5)	10 (22)	7 (103)	1.0 (35)	5.1	2040	–
IR10PV	22 hex. × 82	Latch	85042000	525 (20.6)	190 (7.5)	10 (22)	7 (103)	1.0 (35)	5.1	2040	90 (66.4)
IR12PV	25 round × 75	Screw	85042018	635 (25.0)	190 (7.5)	12 (26.5)	7 (103)	0.9 (32)	3.8	1260	–
IR12PV	22 hex. × 82	Screw	85042026	635 (25.0)	190 (7.5)	12 (26.5)	7 (103)	0.9 (32)	3.8	1260	–
IR12PV	22 hex. × 82	Latch	85042034	644 (25.3)	190 (7.5)	12 (26.5)	7 (103)	0.9 (32)	3.8	1260	90 (66.4)

PARTS LIST

Ref.	Part Name	Cpn	
		IR10PV	IR12PV
1	Cylinder Assembly (22 Hex x 82 nozzle) Latch model	85042470	85042588
1	Cylinder Assembly (22 Hex x 82 nozzle) Screw model	85042596	85042604
1	Cylinder Assembly (25 Round x 75 nozzle) Screw mode	85042612	85042620
2	Nozzle 22 hex x 82	85042638	85042638
2	Nozzle 25 round x 75	85042646	85042646
3	Piston		
4	Valve Ring	85042653	85042661
5	Cylinder plug	85042679	85042679
6	Cylinder spring	85042687	85042695
7	Anti-rotation key	85042703	85042703
8	Sealing ring (Not fitted to Latch retainer models)	85042711	85042711
9	Muffler	85042729	85042729
10	Bearing sleeve	85042737	85042745
11	Cylinder nut	85042752	85042760
12	Screw fronthead	85042778	85042778
13	Chisel buffer	85042786	85042786
14	Latch Fronthead Assembly	85042216	85042216
15	Latch Fronthead	85040624	85040624
16	Fronthead Screw	85040632	85040632
17	Fronthead Nut	85040996	85040996
18	Fronthead Spring Pin Inner	85041010	85041010
19	Fronthead Spring Pin Outer	85040954	85040954
20	Latch	85040970	85040970
21	Plunger Spring	85040731	85040731
22	Plunger	85040947	85040947
23	Handle Assembly	85040921	85040921
24	Handle Body	85042794	85042794
25	Trigger	85042802	85042802
26	Trigger Pin	85042240	85042240
27	Trigger Ball	85042257	85042257
28	Trigger Spring	85042265	85042265
29	Throttle valve plug	85042273	85042273
30	Inlet Bushing	85042810	85042810
31	Quick Coupling EU	85040897	85040897
31	Quick Coupling USA	85040905	85040905
32	Throttle pin	85040913	85040913
		85042828	85042828

Ref.	Part Name	Cpn	
		IR10PV	IR12PV
33	Valve spring pin outer	85042836	85042836
34	Valve spring pin inner	85042844	85042844
35	Plug	85042851	85042851
36	O-ring	85042869	85042869
37	O-ring	85042877	85042877
38	O-ring	85042885	85042885
39	O-ring	85042893	85042893
40	Lock ring	85042901	85042901
41	Latch Kit	85041309	85041309
16	Fronthead Screw	85040996	85040996
17	Fronthead Nut	85041010	85041010
18	Fronthead Spring Pin Inner	85040954	85040954
19	Fronthead Spring Pin Outer	85040970	85040970
20	Latch	85040731	85040731
21	Plunger Spring	85040947	85040947
22	Plunger	85040921	85040921
	Items not illustrated		
52*	Noise Sticker 107	85040210	-
52*	Noise Sticker 105	-	85042562
53*	Warning Sticker	85040202	85040202
54*	Warranty card	85040285	85040285
55*	Box Label EU	85042299	85042299
56*	Box Label USA	85042307	85042307
57*	Box	85042315	85042315
58*	Box insert (fronthead)	85042323	85042323
59*	Box insert (handle)	85042919	85042919
60*	Op & maint. manual IR10PV & IR12PV	85042927	85042927
61*	Name plate sticker	85042935	85042935
69*	Inline lubricator	35371111	35371111
70*	Protec Engine oil 5 l	85448405	85448405

(Items marked * not illustrated)

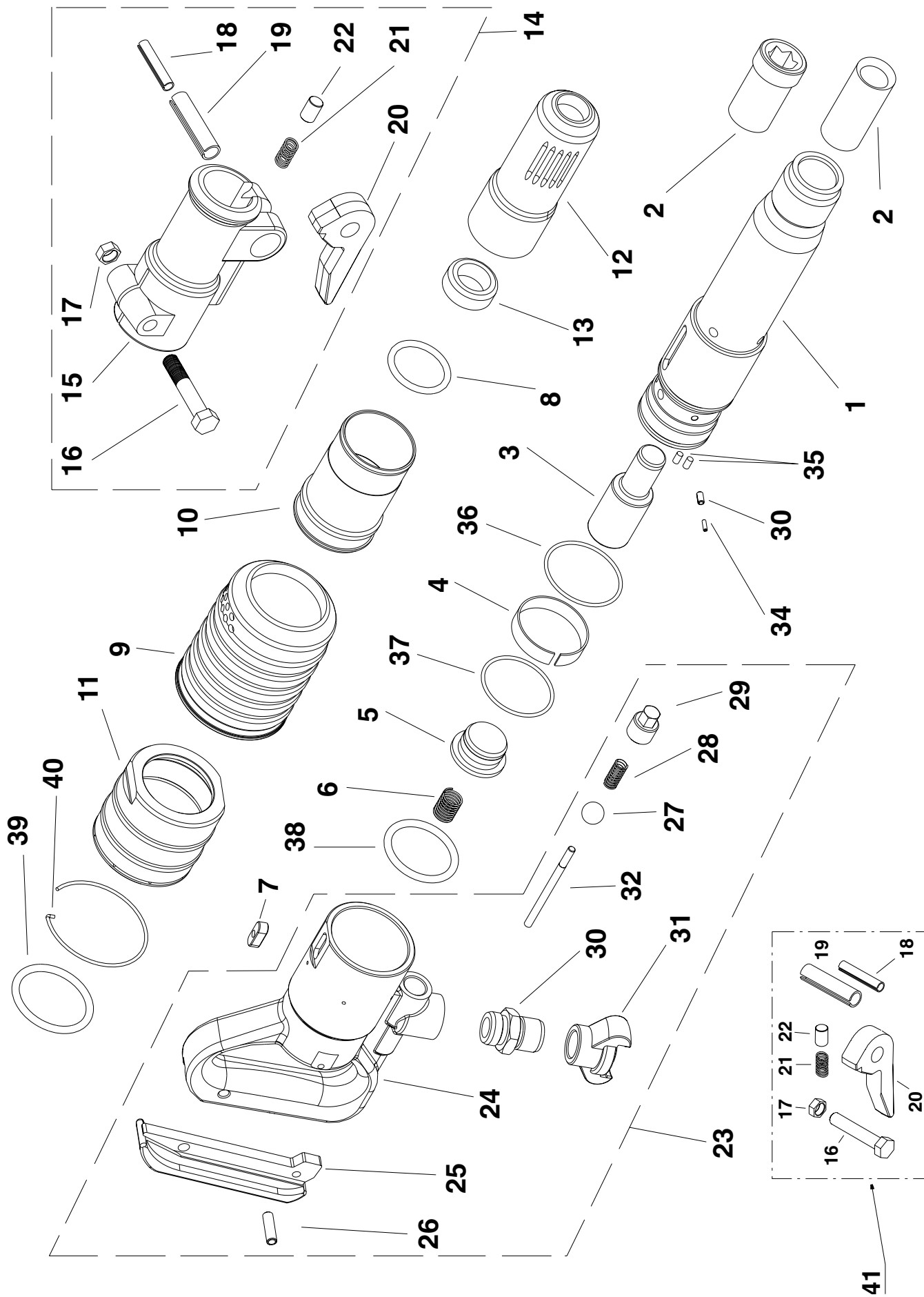



Ingersoll – Rand Company
Portable Power Division P.O. Box 868
501 Sandford Avenue
Mocksville,
North Carolina 27028
USA

Ingersoll – Rand Company Ltd
Portable Power Division
Swan Lane
Hindley Green
Wigan WN2 4EZ
United Kingdom

www.portablepower.irco.com